

# LG1 Series

## Adapter Plates

LGX-118 Compatible (1.15" x 5.10")

For Use in Any LGX Compatible  
Wall or Rack Mount Enclosure

CCH Compatible to LGX-118  
Conversion Plate

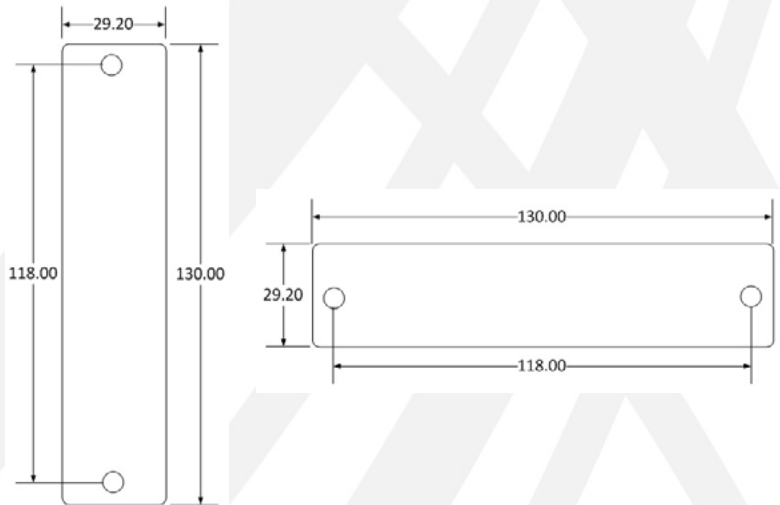

Tii's adapter plates are designed to provide a wide variety of adapter configurations in any LGX-118 compatible panel. The LG1 has a simple push-in design that fits Tii's Rack Mount, Wall Mount or other fiber enclosures making it easy to add additional ports as needed. A large selection of options are available including high density adapters.

### KEY PRODUCT BENEFITS

- ▶ Wide variety of Adapter options
- ▶ Available in Black, White or Almond colors
- ▶ Compatible with any manufacturers panel LGX compliant

### STANDARDS COMPLIANCE

- ▶ LGX-118



**Tii Technologies Inc.**









**Corporate Headquarters:**

141 Rodeo Drive  
Edgewood, NY 11717  
Phone: 631.789.5000 • Fax: 631.789.5063  
Toll Free: 888.844.4720  
sales@tiitech.com

[www.tiitech.com](http://www.tiitech.com)

# LG1 Series

## ORDERING INFORMATION

	STYLE	ADAPTERS	FIBER PORTS	USE	HOUSING	SLEEVE	MODEL #
	FC	6	6	SM/MM	Metal	Zirconia	<b>LG1-FC06SR-X</b>
	FC	8	8	SM/MM	Metal	Zirconia	<b>LG1-FC08SR-X</b>
	FC	12	12	SM/MM	Metal	Zirconia	<b>LG1-FC12SR-X</b>
	FC APC	6	6	SM APC	Metal	Zirconia	<b>LG1-FA06SR-X</b>
	FC APC	8	8	SM APC	Metal	Zirconia	<b>LG1-FA08SR-X</b>
	FC APC	12	12	SM APC	Metal	Zirconia	<b>LG1-FA12SR-X</b>
	LC Duplex	6	12	SM	Blue	Zirconia	<b>LG1-LC06D1-X</b>
	LC Duplex	6	12	SM APC	Green	Zirconia	<b>LG1-LC06D3-X</b>
	LC Duplex	6	12	MM	Beige	PB	<b>LG1-LC06DB-X</b>
	LC Duplex	6	12	MM	Aqua	PB	<b>LG1-LC06DA-X</b>
	LC Quad	6	24	SM	Blue	Zirconia	<b>LG1-LC06Q1-X</b>
	LC Quad	6	24	SM APC	Green	Zirconia	<b>LG1-LC06Q3-X</b>
	LC Quad	6	24	MM	Beige	PB	<b>LG1-LC06QB-X</b>
	LC Quad	6	24	MM	Aqua	PB	<b>LG1-LC06QA-X</b>
	SC	6	6	SM	Blue	Zirconia	<b>LG1-SC06S1-X</b>
	SC	6	6	SM APC	Green	Zirconia	<b>LG1-SC06S3-X</b>
	SC	6	6	MM	Beige	PB	<b>LG1-SC06SB-X</b>
	SC	6	6	MM	Aqua	PB	<b>LG1-SC06SA-X</b>
	SC	8	8	SM	Blue	Zirconia	<b>LG1-SC08S1-X</b>
	SC	8	8	SM APC	Green	Zirconia	<b>LG1-SC08S3-X</b>
	SC	8	8	MM	Beige	PB	<b>LG1-SC08SB-X</b>
	SC	8	8	MM	Aqua	PB	<b>LG1-SC08SA-X</b>
	SC Duplex	6	12	SM	Blue	Zirconia	<b>LG1-SC06D1-X</b>
	SC Duplex	6	12	SM APC	Green	Zirconia	<b>LG1-SC06D3-X</b>
	SC Duplex	6	12	MM	Beige	PB	<b>LG1-SC06DB-X</b>
	SC Duplex	6	12	MM	Aqua	PB	<b>LG1-SC06DA-X</b>
	ST	6	6	SM/MM	Metal	Zirconia	<b>LG1-ST06SR-X</b>
	ST	6	6	MM	Metal	PB	<b>LG1-ST06SK-X</b>
	ST	8	8	SM/MM	Metal	Zirconia	<b>LG1-ST08SR-X</b>
	ST	8	8	MM	Metal	PB	<b>LG1-ST08SK-X</b>
	ST	12	12	SM/MM	Metal	Zirconia	<b>LG1-ST12SR-X</b>
	ST	12	12	MM	Metal	PB	<b>LG1-ST12SK-X</b>
	NONE	0	0	N/A	N/A	N/A	<b>LG1-BLANK-X</b>
	CCH Style Conversion Plate for LG1 Series						<b>LG1-CCH</b>

Replace "-x" with plate color option: "-B" = black, "-W" = white, "-M" = almond/beige